

If you have any questions, please contact me at jamie@teachmommyteach.com

Thank you for downloading!

You May:

- use these resources in your own home or classroom for non-commercial use.
- print as many copies as you would like.
- share the website link, <https://teachmommyteach.com/>, where this printable can be found, so that others can download the file.

You May NOT:

- sell, give away, or share a printed copy. Each person should download separately and print.
- print out a copy for multiple teachers, as in an entire school, co-op, or other group. Each teacher should download separately and print.
- link directly to the pdf. Instead, link to the page on <https://teachmommyteach.com/> or <https://teacherspayteacher.com/> where you found the download.
- claim this or any part of this printable as your own.
- alter this printable and claim it as your own.
- host any of the files on your personal or other websites that can be shared with others.
- Upload this resource to any file sharing sites

Credits!! Thank you Speaking of Images and Open Clipart!



<https://www.teacherspayteachers.com/Store/Speaking-Of-Images>



<https://openclipart.org/>

More Beginning Readers 12: Let's Go

Pre-Reading Worksheets

Your child will practice *CVC* words and *CCVC* words. Your child will read a contraction word, *let's*.

Name: _____

Glue the books in the correct backpack.

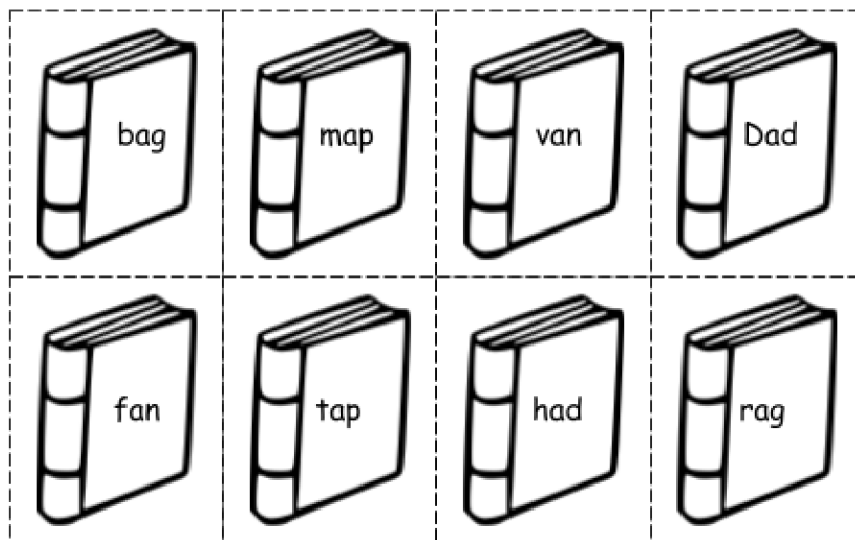

Thank you openclipart.org for the amazing clipart!

Name: _____

Glue the toys in the appropriate gift.

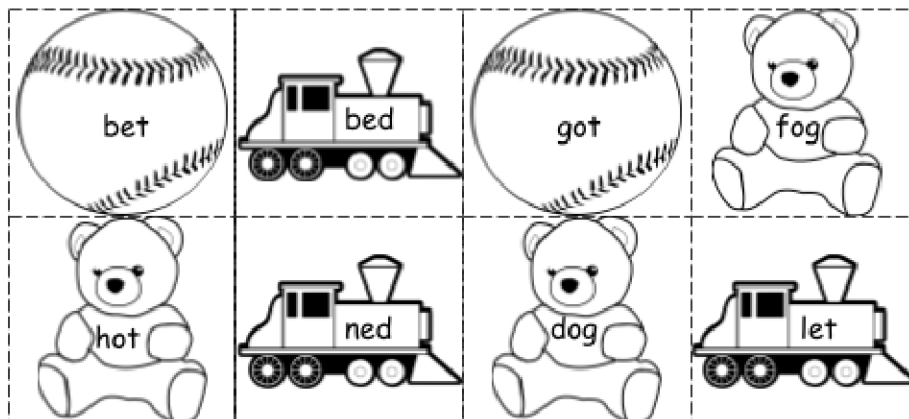

Thank you openclipart.org for the wonderful clipart!

Name: _____

Read the two words below. Cut out the graphemes (letters) below. Then match the graphemes (letters) to the pictures of the mouths saying the words, and glue. Write the words on the handwriting lines.

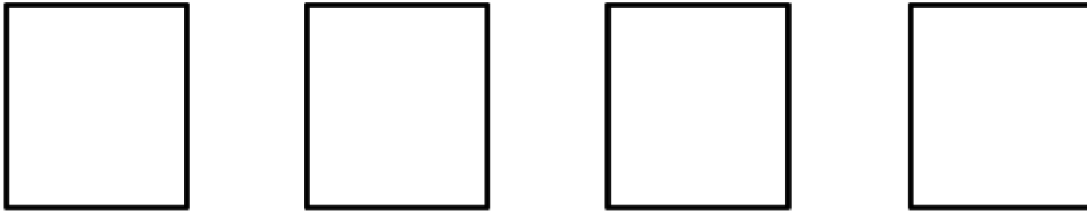
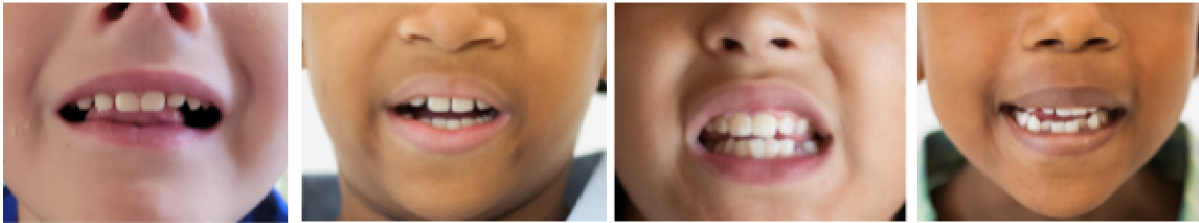

l	e	t'	s	M	o	m
---	---	----	---	---	---	---

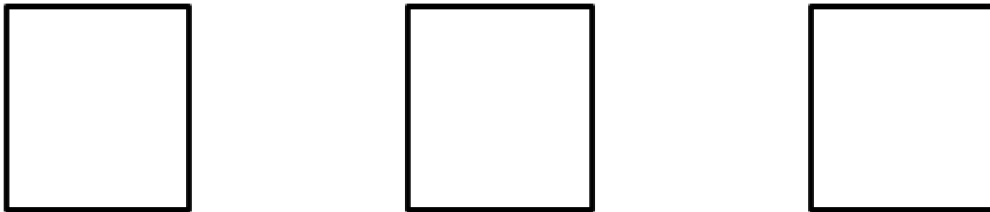

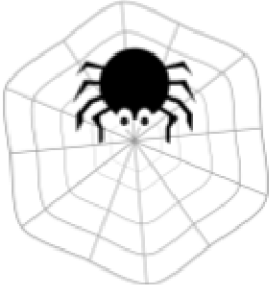

Name: _____

The words below all begin with tr-. Circle the TR in each word.

			
trip	trap	trim	trot

A contraction is a shortened version of one or two words. You use an apostrophe to take the place of one or more letters in the word. Below are some contractions. Can you circle the apostrophe in the contractions? Can you place an X over the letter it replaced?

Let us = Let's

Did not = Didn't

Read the following silly sentences. Circle the contractions. Box the word trip.

The pig went on a trip in a van.

The hen didn't go on a trip.

Let's go visit hen.

Thank you openclipart.org for the awesome clipart!!

Name: _____

Remember, if there is more than one item, we add an -s. If the last sound in the word is voiced, the s represents a z sound. If the last sound of the word is voiceless, the s represents a s sound.

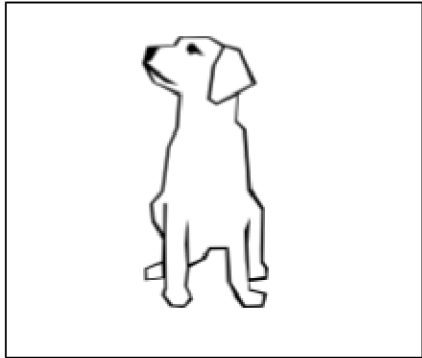

1 dog

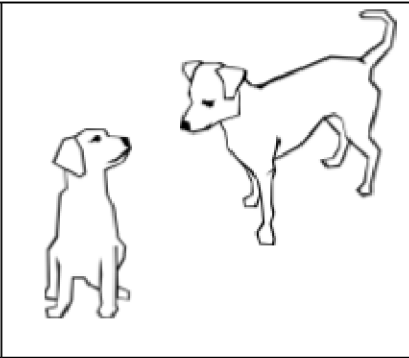

2 dogs

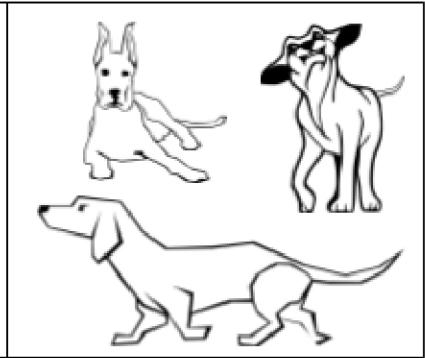

3 dogs

Add an -s when appropriate. Practice using the correct sound for the -s.

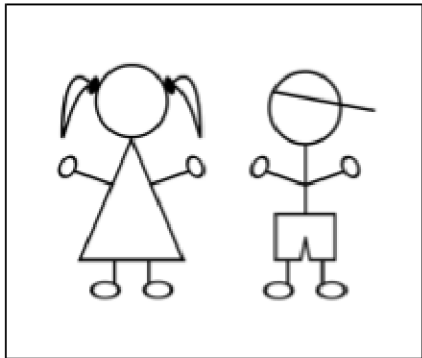

2 kid



30 kid



7 kid

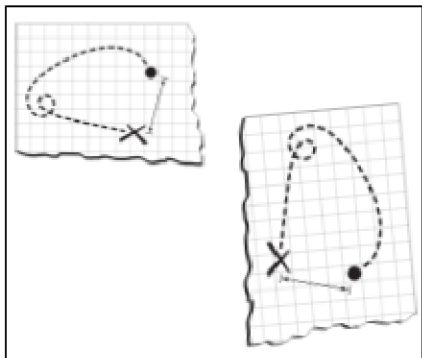

2 map

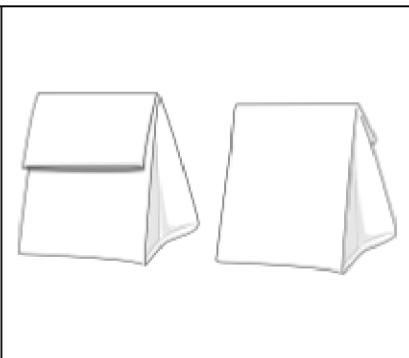

2 bag

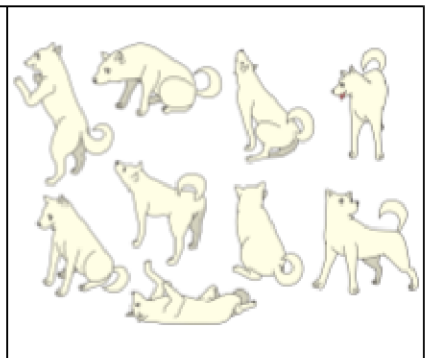

9 dog

Thank you openclipart.org for the wonderful clipart!

More Beginning Readers 12: Let's Go

Extra Practice Post-Reading Worksheets

Name: _____

Read the following silly sentences. Then draw a picture to illustrate each silly sentence.

The cat and dog got in a van. Let's go!

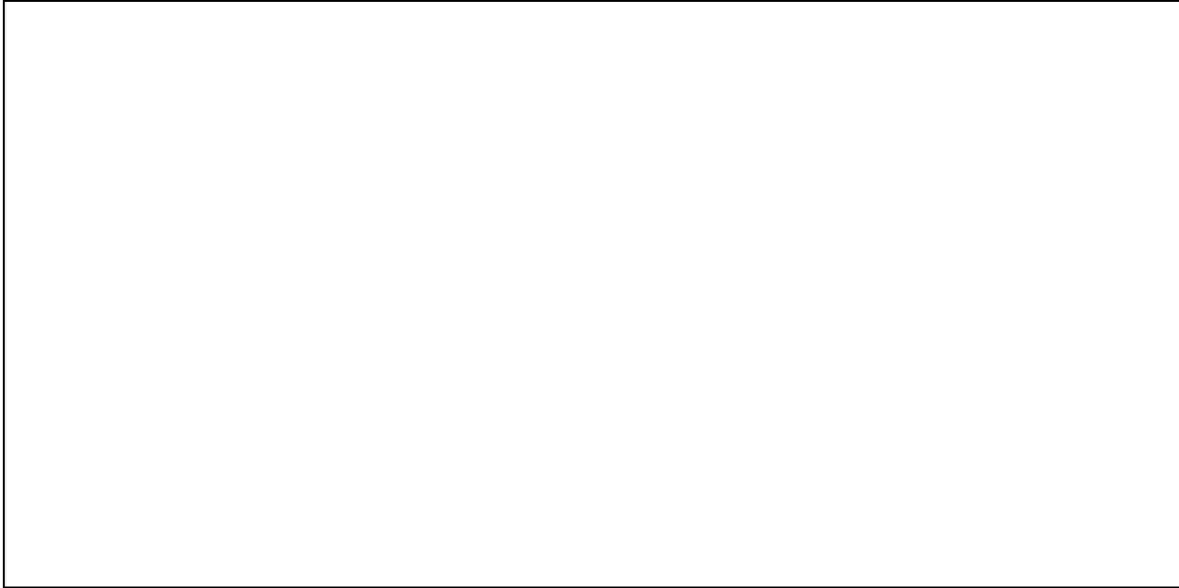

The cat and dog visit the kids!

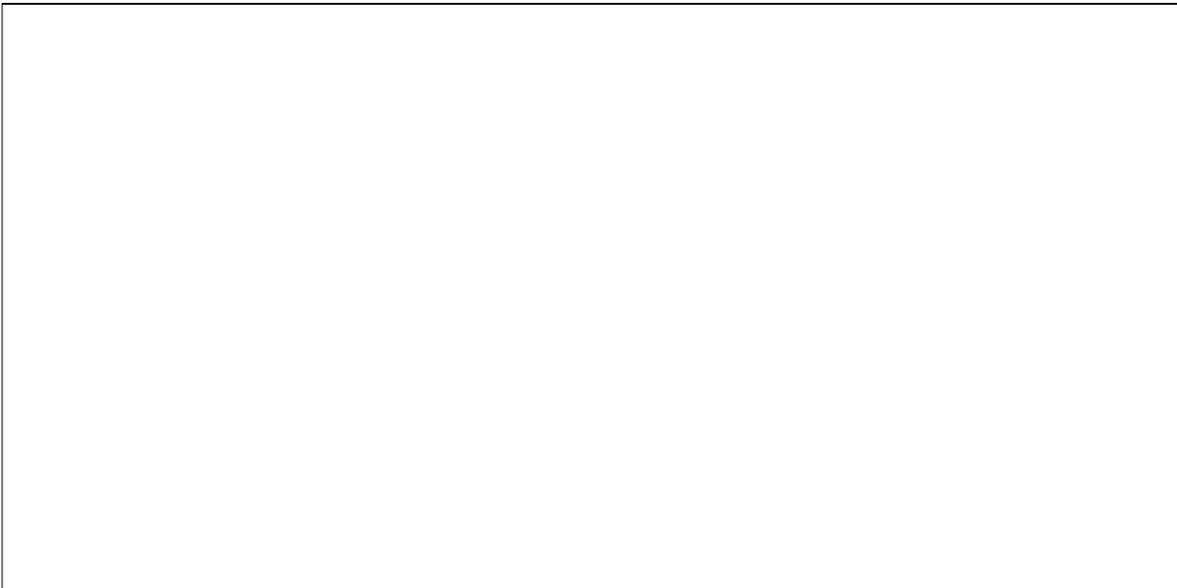

Name: _____

Finish writing each word that represents the picture next to it. As you go down the list, each word will only change 1 grapheme (letter or letters that represent one sound.)



men



m_____n



_____an

More Beginning Readers 12: Let's Go

Answers Pre-Reading Worksheets

Your child will practice *CVC* words and *CCVC* words. Your child will read a contraction word, *let's*.

Name: Answers

Glue the books in the correct backpack.

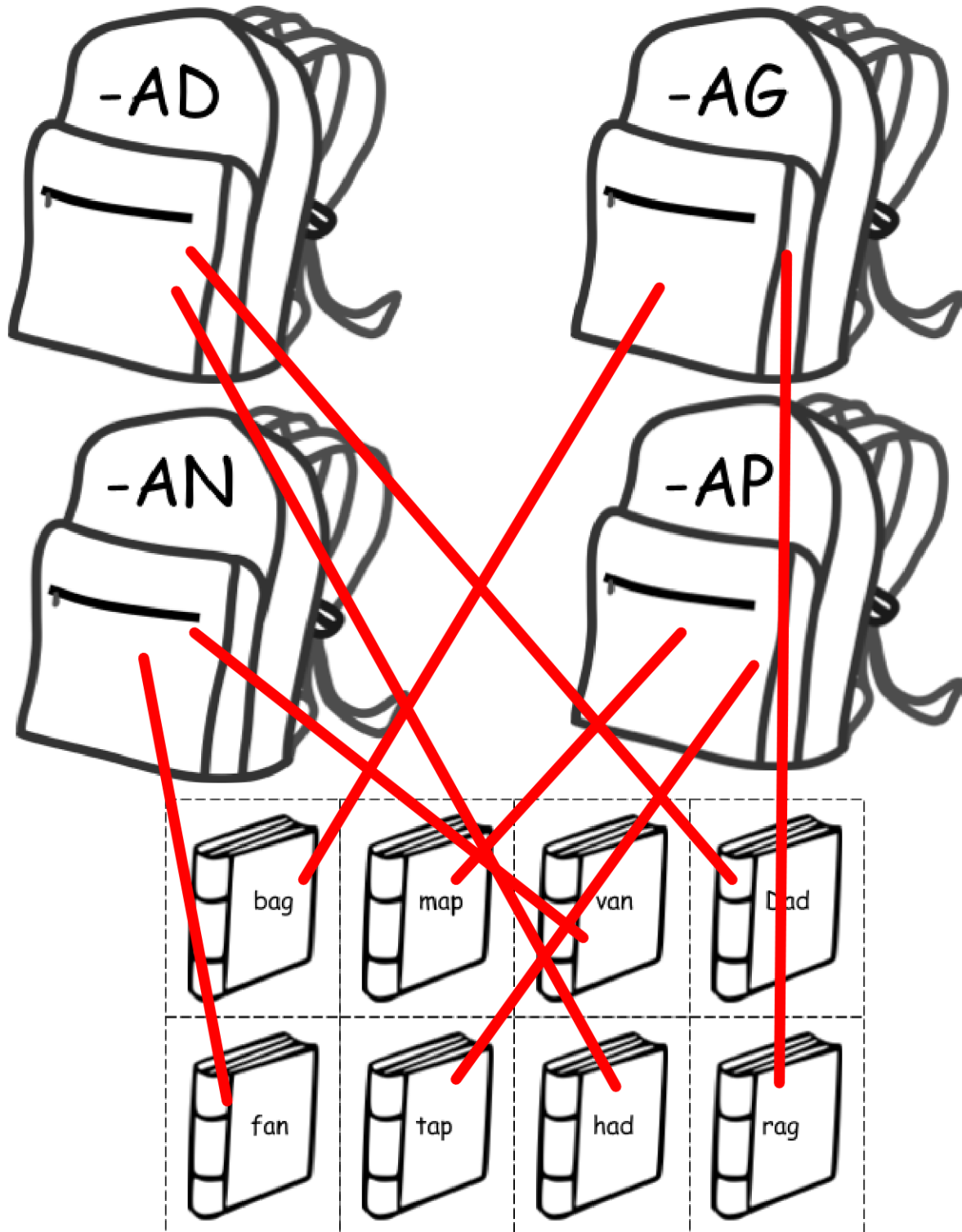

Thank you openclipart.org for the amazing clipart!

Name: Answers

Glue the toys in the appropriate gift.

The image shows a matching activity with four gift boxes and eight toys. The gift boxes are labeled with suffixes: -ET, -ED, -OT, and -OG. The toys are arranged in a 2x4 grid and labeled as follows:

bet	bd	dot	fog
hot	ned	dog	let

Red lines indicate the following connections:

- ET connects to bet
- ED connects to dot
- OT connects to dog
- OG connects to fog

Thank you openclipart.org for the wonderful clipart!

Answers

Name: _____

Read the two words below. Cut out the graphemes (letters) below. Then match the graphemes (letters) to the pictures of the mouths saying the words, and glue. Write the words on the handwriting lines.

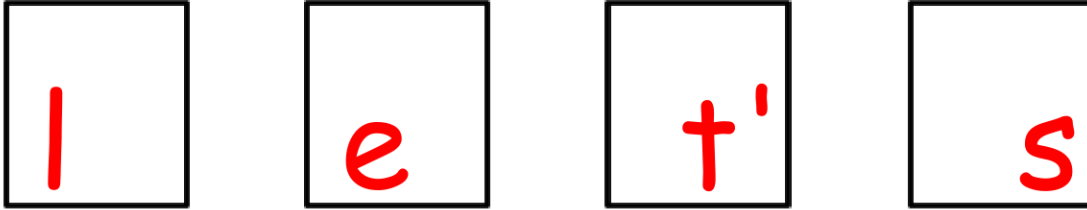
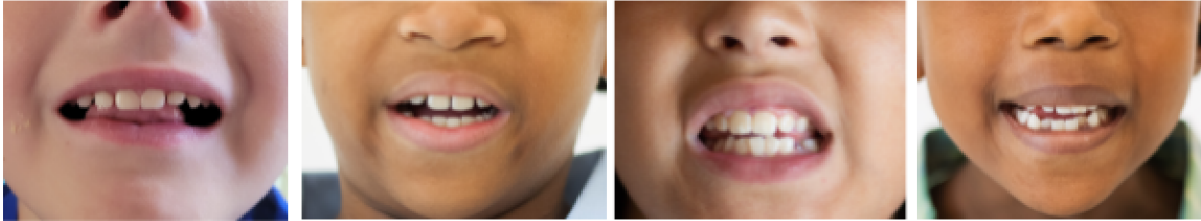
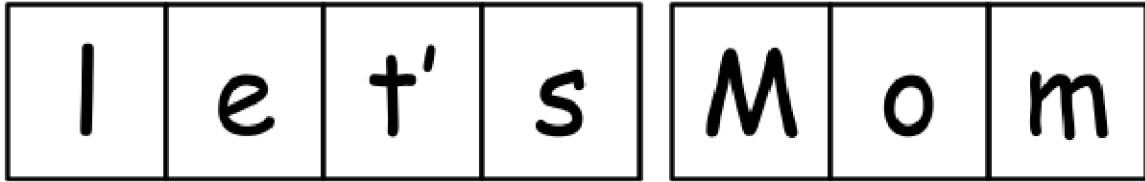

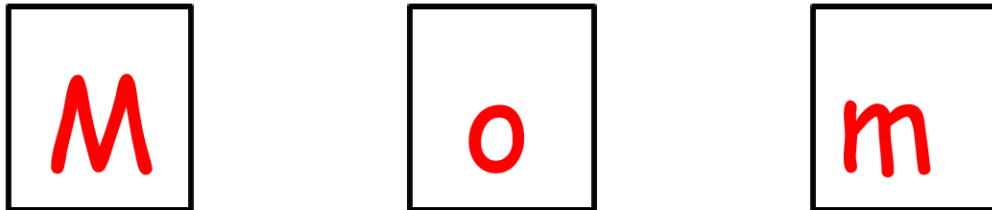

lets



Mom

Name: Answers

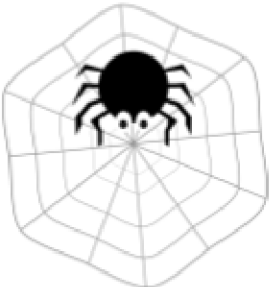
The words below all begin with tr-. Circle the TR in each word.

 <p>trip</p>	 <p>trap</p>	 <p>trim</p>	 <p>trot</p>
--	--	---	--

A contraction is a shortened version of one or two words. You use an apostrophe to take the place of one or more letters in the word. Below are some contractions. Can you circle the apostrophe in the contractions? Can you place an X over the letter it replaced?

Let us = Let's

Did not = Didn't

Read the following silly sentences. Circle the contractions. Box the word trip.

The pig went on a **trip** in a van.

The hen didn't go on a **trip**

Let's go visit hen.

Thank you openclipart.org for the awesome clipart!!

Name: **Answers**

Remember, if there is more than one item, we add an -s. If the last sound in the word is voiced, the s represents a z sound. If the last sound of the word is voiceless, the s represents a s sound.

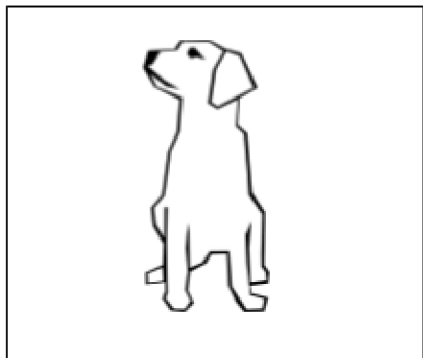

1 dog

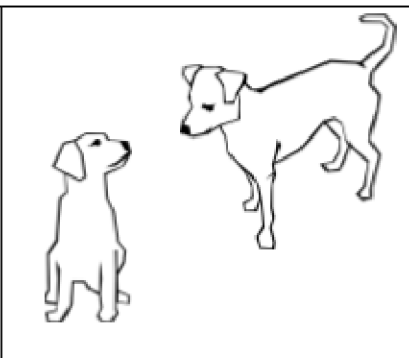

2 dogs

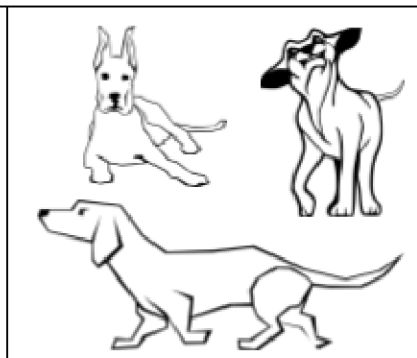

3 dogs

Add an -s when appropriate. Practice using the correct sound for the -s.

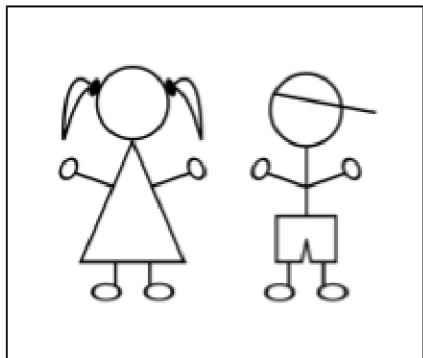

2 kid_s



30 kid_s



7 kid_s

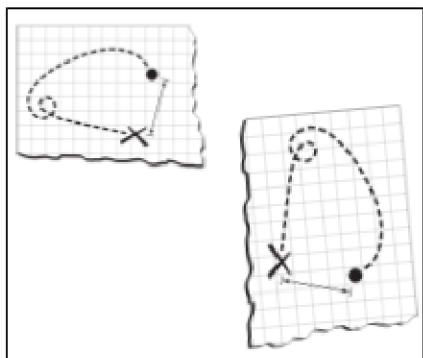

2 map_s

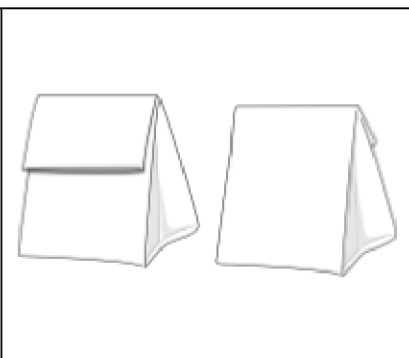

2 bag_s

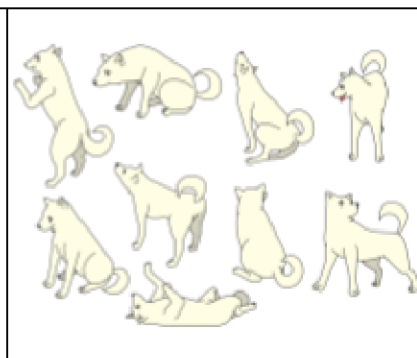

9 dog_s

Thank you openclipart.org for the wonderful clipart!

More Beginning Readers 12: Let's Go

Answers
Extra Practice
Post-Reading Worksheets

Name: Answers

Read the following silly sentences. Then draw a picture to illustrate each silly sentence.

The cat and dog got in a van. Let's go!

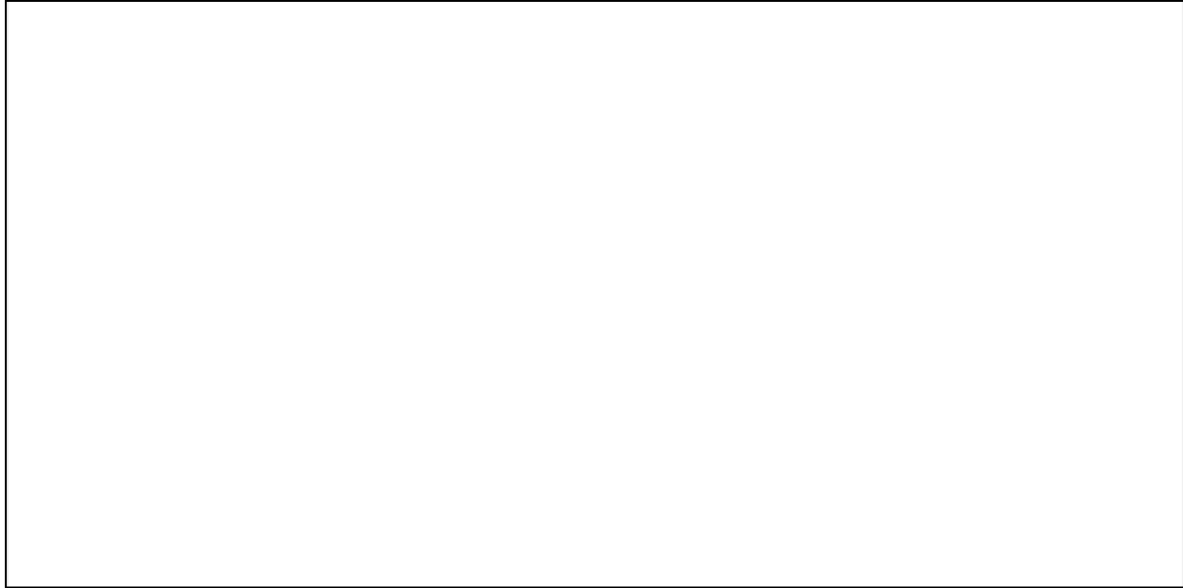

The cat and dog visit the kids!

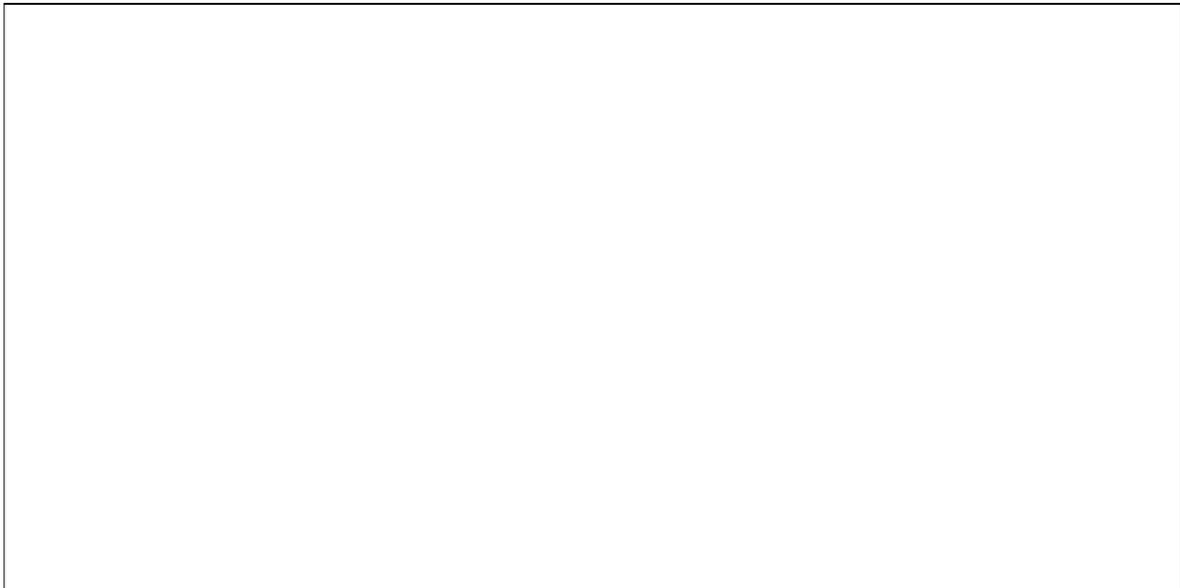

Answers

Name: _____

Finish writing each word that represents the picture next to it. As you go down the list, each word will only change 1 grapheme (letter or letters that represent one sound.)

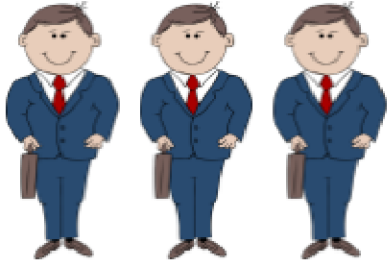

men



m _ a _ n



_ v _ an